







CL.1 Deck valve clockwise closing cold - Champagne (22kt Gold)

CL.1

20 000 705

- hole diameter valve 32 mm
- rosette 60 x 60 mm
- with cold marking



	Champagne (22kt Gold)	20 000 705-47
	Chrome	20 000 705-00
	Brushed Platinum	20 000 705-06
	Dark Chrome	20 000 705-19
	Brushed Champagne (22kt Gold)	20 000 705-46
	Brushed Dark Platinum	20 000 705-99

20 000 705

mm [inches]

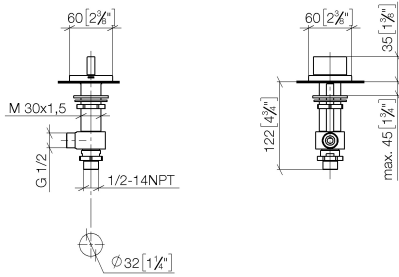

Flow rate chart

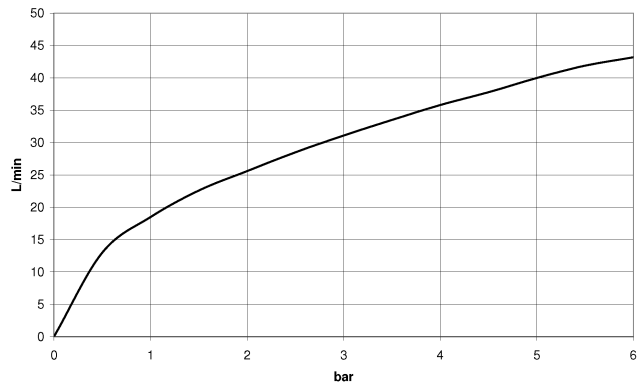

Codes & Standards

ADA

ASME
A112.18.1/CSA
B125.1



CL.1 Deck valve clockwise closing cold - Champagne (22kt Gold)

CL.1

20 000 705

Certificates

WRAS_2103001.

20 000 705

Parts for other finishes can be found here: [Chrome](#)

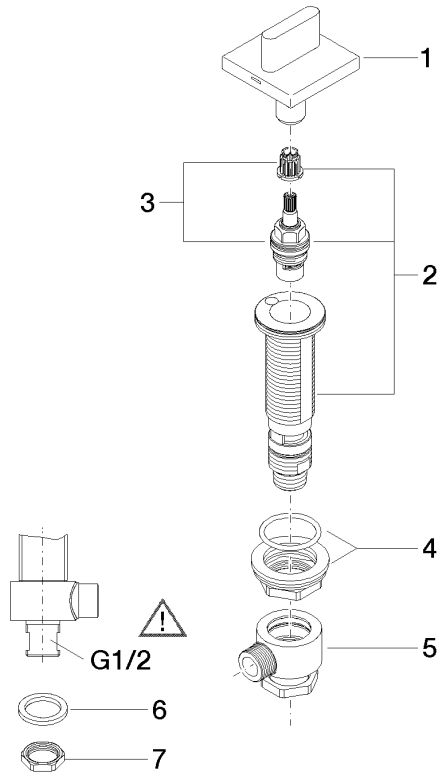

Spare parts list

No.	Item Number	Name	Quantity used	Delivery time
1	90 20 70 051 04-47	handle (cold)	1	30
2	04 17 11 058 33 90	side panel	1	2
3	90 90 03 133 00 90	top	1	2
4	04 23 10 032 78 90	fixing set	1	2
5	04 17 11 023 10 90	distributor	1	2
6	90 23 30 040 00-47	threaded connector	1	30
7	09 30 11 059 90	disc	1	2
8	09 23 10 012 90	nut	1	2